



2-Wire, 2-Channel  
Signal Isolator/Convertor

**MIX**

**miniMOORE™**  
minimum footprint MOORE PERFORMANCE  
**User's Manual**

All product names are registered trademarks of their respective companies.

## Customer Support

Moore Industries is recognized as the industry leader in delivering top quality to its customers in products and services. We perform a sequence of stringent quality assurance checks on every unit we ship. If any Moore Industries product fails to perform up to rated specifications, call us for help. Our highly skilled staff of trained technicians and engineers pride themselves on their ability to provide timely, accurate, and practical answers to your process instrumentation questions. Our headquarters and other facilities phone numbers are listed below.

There are several pieces of information that can be gathered before you call the factory that will help our staff get the answers you need in the shortest time possible. For fastest service, gather the complete model and serial number(s) of the problem unit(s) and the job number of the original sale.

## Locations

### World Headquarters

16650 Schoenborn Street  
North Hills, California  
91343-6196, **U.S.A.**  
Tel: (818) 894-7111  
Fax: (818) 891-2816  
E-mail: [info@miinet.com](mailto:info@miinet.com)  
TOLL FREE: 1-800-999-2900  
**[www.miinet.com](http://www.miinet.com)**

### Europe

1 Lloyds Court, Manor Royal,  
Crawley  
W. Sussex RH10-9QU  
**United Kingdom**  
Tel: 01293 514488  
Fax: 01293 536852  
FREE PHONE: 0800 525107  
[sales@mooreind.com](mailto:sales@mooreind.com)

### Australia

Sydney, NSW  
3/1 Resolution Drive  
Caringbah, New South Wales 2229  
**Australia**  
Tel: (02) 8536-7200  
Fax: (02) 9525-7296  
[sales@mooreind.com.au](mailto:sales@mooreind.com.au)

### China

Room 402, No. 57,  
Lane 651, Xipu Road,  
Xinqiao Town, Songjiang District,  
**Shanghai**, 201612, P. R. China  
Tel: 86-21 62491499  
Fax: 86-21 62490635  
E-mail: [sales@mooreind.sh.cn](mailto:sales@mooreind.sh.cn)

### **BeNeLux**

Guido Gezellestraat 106  
BE-2630 Aartselaar  
**Belgium**  
Tel: 03/448.10.18  
Fax: 03/440.17.97  
[info@mooreind.eu](mailto:info@mooreind.eu)

Perth, WA  
6/46 Angove Street  
North Perth, Western Australia 6006  
**Australia**  
Tel: (08) 9228-4435  
Fax: (08) 9228-4436  
[sales@mooreind.com.au](mailto:sales@mooreind.com.au)



[www.miinet.com](http://www.miinet.com)

# Table of Contents

<b>Introduction.....</b>	<b>4</b>
About this Manual .....	4
Model and Serial Numbers .....	4
Inputs and Ouputs.....	4
<b>Specifications .....</b>	<b>5</b>
<b>Dimensions .....</b>	<b>5</b>
<b>Accessories .....</b>	<b>6</b>
Docking Clamping Tool and Loop ID Location .....	6
Wire Termination .....	6
Wire Installation .....	6
<b>Calibration.....</b>	<b>7</b>
Calibration Setup .....	7
Calibration Procedure .....	7
<b>Installation.....</b>	<b>8</b>
Recommended Ground Wiring Practices.....	8
CE Conformity.....	8
Installation in Hazardous Locations .....	8
Specific Conditions of Use .....	8
Electrical Connections .....	8
Installation Category .....	9
Equipment Ratings.....	9
Supply Wiring.....	9
Mounting .....	9
Cleaning and Maintenance .....	9
Replacement of Consumable Materials .....	9
Customer Support.....	9
Symbols .....	10
<b>Warranty .....</b>	<b>11</b>

# MIX

2-Wire, 2-Channel  
Signal Isolator/Converter

## Introduction

This is the users' manual for Moore Industries' miniMOORE MIX 2-Wire, 2-Channel Signal Isolator/Converter. The output loop-powered MIX provides 1000Vrms input-to-output, channel-to-channel isolation, and signal isolation between two non-isolated transmitters and a receiving device. This eliminates faulty readings in process measurements caused by ground loops, motor noise, and other unpredictable electrical interference.

The MIX provides two individual channels with user selectable inputs and two 4-20mA outputs ready for direct interface with a receiving device.

## About this Manual

Wherever you see a "**WARNING**", "**Caution**" or "**Note**" pay particular attention.

**WARNING** - Hazardous procedure or condition that could injure the operator.

**Caution** - Hazardous procedure or condition that could damage or destroy the unit.

**Note** - Information that is helpful for a procedure, condition, or operation of the unit.

**Figure 1.** The MIX has two user selectable inputs and two 4-20mA outputs

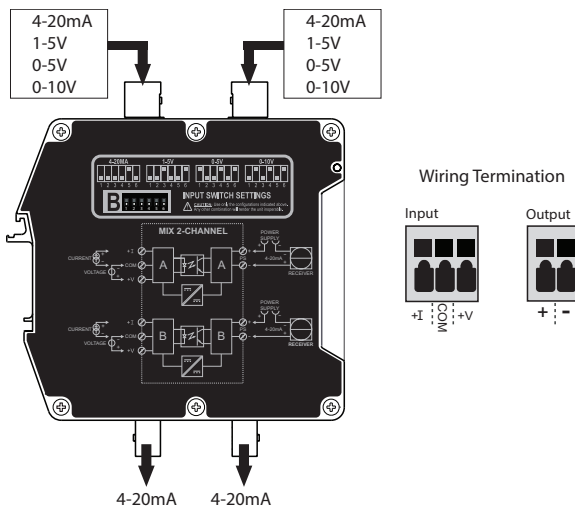

## Model and Serial Numbers

Moore Industries uses a system of model and serial numbers to keep track of all of the information on every unit it sells and services. If a problem occurs with your MIX, check for a tag affixed to the unit listing these numbers. Supply the Customer Support representative with this information when calling.

## Inputs and Outputs

The 2-wire, 2-channel MIX has two independent switch configurable inputs 4-20mA, 1-5V, 0-5V, or 0-10V with two corresponding isolated 4-20mA outputs. Switch selectable inputs are accessible on side of unit. (See Figures 1 and 2). The front panel of the unit has two adjustments per channel, Zero ( $\pm 5\%$ ) and Span ( $\pm 10\%$ ) pot for adjustment as needed or required.

**Figure 2.** Settings for Channels A and B input ranges

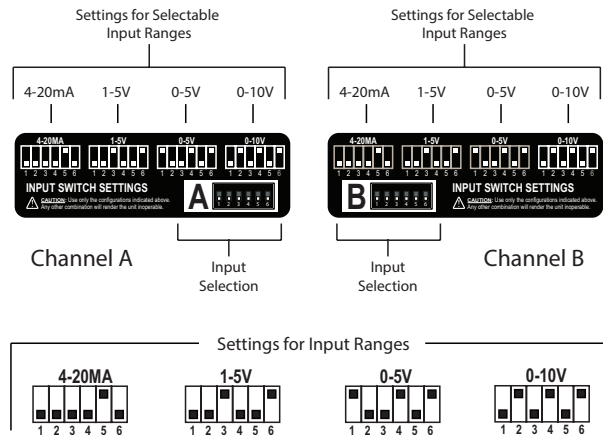

### Specifications

2-Wire, 2-Channel Output-Loop Powered Isolator		
<p><b>Performance</b></p> <p><b>Accuracy:</b> ±0.1% of span (includes input accuracy, output accuracy, and the combined effects of linearity, hysteresis and repeatability)</p> <p><b>Stability:</b> ±0.2% of reading per year</p> <p><b>Isolation:</b> 1000Vrms between inputs and outputs and channel to channel</p> <p><b>Output Response Time:</b> 100msec maximum to 99% of output change; 50msec to 90% output change</p> <p><b>DC Input Resistance:</b> 50 ohms for current; 1 Mohm for voltage</p> <p><b>Ripple:</b> &lt;10mV peak-to-peak maximum measured across a 250 ohm resistor</p> <p><b>Over-Voltage Protection:</b> 42V maximum on output; 42V reverse polarity protection on output</p>	<p><b>Performance (continued)</b></p> <p><b>Maximum Input Over Range:</b> Current inputs, 100mA Voltage inputs, 150% of full scale</p> <p><b>Burden:</b> 1V maximum</p> <p><b>Load Capability:</b> <math display="block">\frac{V_s - 12V_{dc}}{0.02A} = \text{ohms}</math></p> <p><b>Output Current Limiting:</b> 25mA typical; 30mA maximum.</p> <p><b>Ambient Conditions</b></p> <p><b>Operating Range:</b> -40°C to +75°C (-40°F to +167°F) @ 12V-24V,  -40°C to +55°C (-40°F to +131°F) @ 12V-42V</p> <p><b>Storage Range:</b> -40°C to +85°C (-40°F to +185°F)</p>	<p><b>Ambient Conditions (Continued)</b></p> <p><b>Ambient Temperature Effect:</b> ±0.007% of span/°C typical; ±0.015% of span/°C maximum.</p> <p><b>Relative Humidity:</b> 0-95% non-condensing</p> <p><b>RFI/EMI Immunity:</b> Less than ±0.1% of span error when tested at 10V/m@20-100MHz</p> <p><b>Common Mode Rejection:</b> Exceeds 95dB at 60Hz with a limit of 500Vrms</p> <p><b>Adjustment</b></p> <p><b>Type:</b> Front panel potentiometers</p> <p><b>Span:</b> ±10%</p> <p><b>Zero:</b> ±5% (non-interactive when span is set first)</p> <p><b>Weight</b> 230g (8.1 oz)</p>

### Dimensions

Figure 3. Aluminum-housed 2-wire, 2-channel MIX dimensions

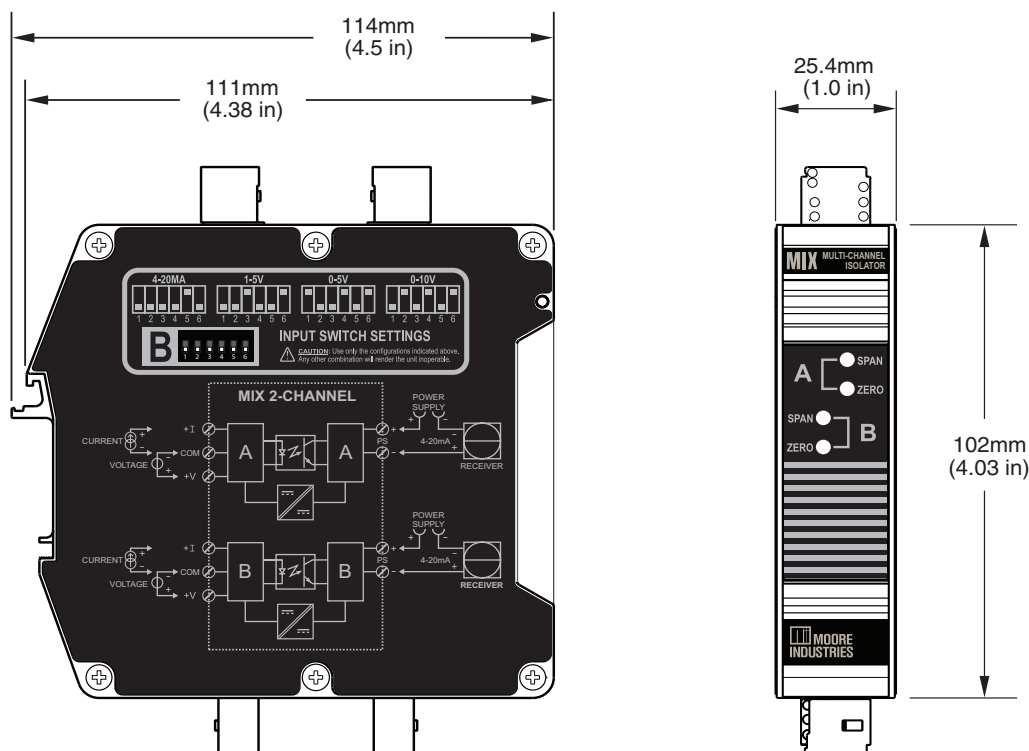

# MIX

2-Wire, 2-Channel  
Signal Isolator/Convertor

## Accessories

Your miniMOORE MIX unit comes with the following accessories:

Figure 4. MIX miniMOORE accessories

miniMOORE User Manuals on CD



miniMOORE Quick Set-Up Guide



Loop ID Label

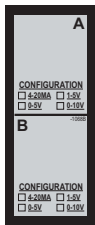

Clamping Tool

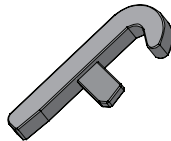

## Docking Clamping Tool and Loop ID Label Location

Figure 5 below illustrates proper location to dock clamping tool after use and correct location for the Loop ID label.

Figure 5. MIX miniMOORE accessories

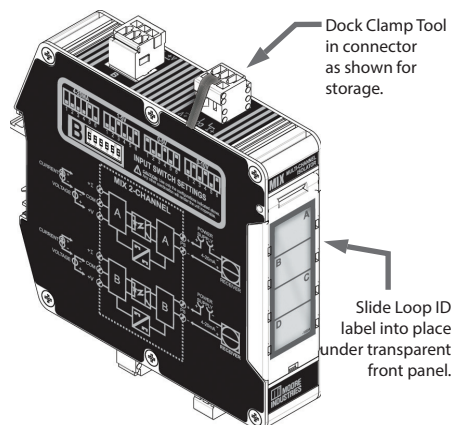

## Wire Termination

Refer to Figure 1 for wire termination for your MIX unit.

## Wire Installation

The connectors must be removed from unit, to properly install wires in each of the connectors.

Figure 6 below, illustrates how to use the wiring clamp tool to correctly install the wire into connector. Insert clamp in proper slot and press downward, this will momentarily open terminal slot. Slide wire into place, and then release pressure on clamp tool to lock wire in place.

After correct wiring, following the wire termination shown in Figure 1, place connector back onto unit. Refer to Figure 5 for proper storage of clamping tool.

Figure 6. Using the clamping tool

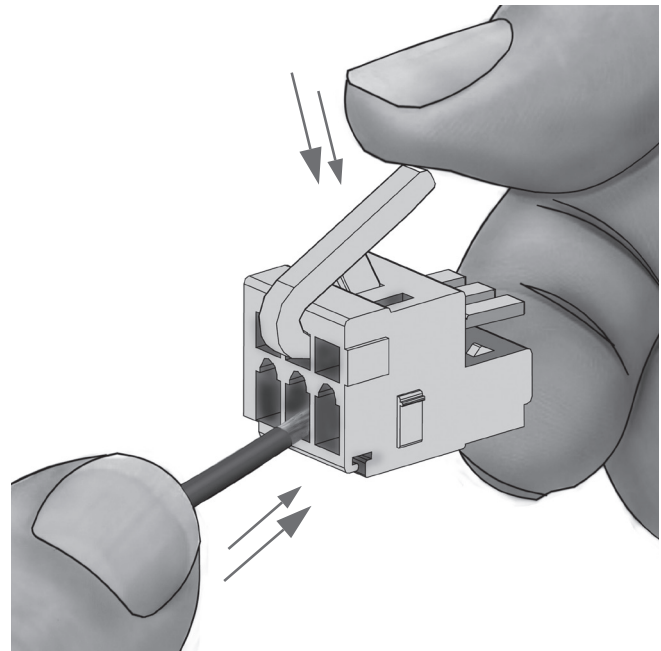

### Calibration

Before placing your MIX into service, a bench check of basic operation is recommended to ensure that the unit hasn't sustained any damage during transit, and to set zero and span for your application. Every unit should be:

- Checked to verify that the appropriate MIX model has been ordered for the intended application.
- Connected in a calibration setup (described later in this section) and checked for desired output.
- Adjusted for desired zero and span settings.

### Calibration Setup

Table 1 lists the equipment you will need to bench check the MIX. These materials are not supplied by Moore Industries, but should be available in environments suited for calibration and maintenance of electronic instruments.

Figure 7 shows the calibration setup for the 2-wire, 2-channel MIX.

Moore Industries recommends that the procedures in this section be carried out at a technician's bench or in a similar, lab-type environment. Do not calibrate the MIX in the field or installed in the application.

**Table 1. Equipment for MIX calibration**

Device	Specification
<b>Current or Voltage Calibrator</b>	Adjustable, calibrated to an accuracy of $\pm 0.025\%$ (EDC Model CR 103 or MV 105, or equivalent)
<b>Power Supply</b>	Calibrated, 12-42Vdc, $\pm 10\%$ , nominal
<b>Load Resistor</b>	250 ohms ( $\pm 0.01\%$ ) precision
<b>Multimeter</b>	Calibrated to an accuracy of $\pm 0.025\%$ , minimum (Keithley Model 197, or Fluke Model 8840 or 8842, or equivalent)
<b>Screwdriver</b>	Standard (Blade-type), head width 2.5mm (0.10 in), maximum

### Calibration Procedure

With the unit incorporated into the appropriate setup (as illustrated in Figure 7):

1. Apply the appropriate power to the "PS" side of the setup.
2. Set the current calibrator to 0% of the rated span for the type of MIX being calibrated.  
  
For example, 4mA for a 4-20mA input unit.
3. Adjust the MIX Zero potentiometer (pot) until the voltmeter in the setup reads 1V plus/minus the stated accuracy specification.
4. Set the calibrator to 100% of the rated span (full scale) of MIX being calibrated.  
  
For example, 20mA for a 4-20mA input unit.

5. Adjust the span potentiometer (pot) until the voltmeter reads 5V plus/minus the stated accuracy specification across the load resistor.
6. Repeat steps 2 through 5 until the voltage across the load resistor is stable and within the rated unit accuracy at both 0% and 100% of span.
7. Move the calibrator and power source to the next channel and repeat steps 1 through 6 for the remaining channel.

**Figure 7. Calibrating the 2-wire, 2-channel MIX**

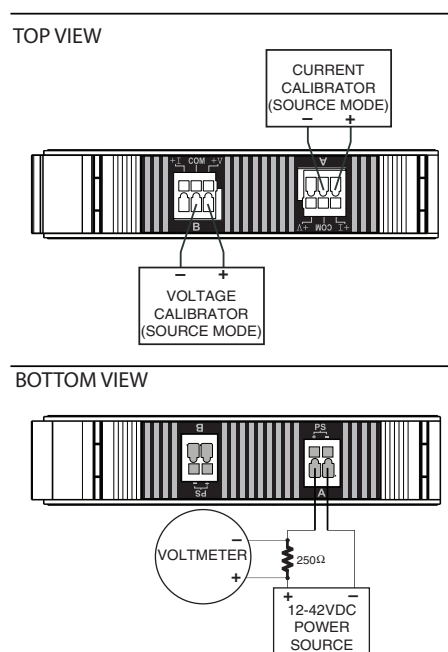

# MIX

2-Wire, 2-Channel  
Signal Isolator/Convertor

## Installation

Figure 3 on page 4 shows the physical dimensions of the MIX. To install the MIX on a DIN-rail, set the appropriate lip on the back of the unit on the top edge of the DIN-rail and pivot downward until the unit snaps into place.

Figure 8 Installing the 2-wire, 4-channel MIX

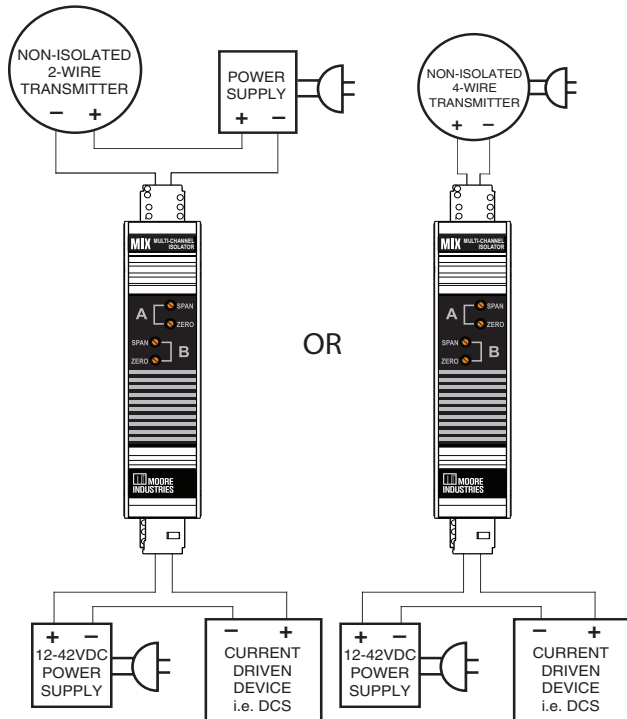

## Recommended Ground Wiring Practices

The following ground wiring practices must be followed to ensure proper performance of the MIX:

- Any Moore Industries' product in a metal case, enclosure or housing should be grounded. Units in DIN housings, for example, should be mounted on a grounded rail.
- All input signals to, and output signals from, Moore Industries' products should be wired using shielded, twisted pair technique. Shields are to be connected to an earth or safety ground at the unit itself.
- The maximum length of any unshielded input and/or output signal wiring is 2 inches.

## CE Conformity

Installation of Moore Industries' products that carry CE marking must adhere to the guidelines in the Recommended Ground Wiring Practices section in order to meet the requirements in EN 61326 and the relevant EMC directive.

Consult the factory for the most current information on products that have been CE certified.

## Installation in Hazardous Locations

This section contains important information regarding installation of the MIX 2 wire 4 channel in Hazardous Area locations.

### **WARNING:**

*Do not disconnect equipment when a flammable or combustible atmosphere is present.*

**Note:** The MIX 2 wire 2 channel is suitable for Class I Division 2, Groups A-D or General Locations only.

## Specific Conditions of Use

The following instructions must be adhered to when the MIX 2 wire 2 channel is used in hazardous locations and potentially explosive atmospheres.

The MIX 2 wire 2 channel shall be installed in compliance with the enclosure, mounting, spacing and segregation requirements of the ultimate application.

cCSAus Installation

Nonincendive Applications

Class I, Division 2, Groups A-D

Electronic components must be mounted in a suitable enclosure.

## Electrical Connections

Figure 8 illustrates the proper hookup for correctly installing an MIX into your process.

### **WARNING:**

*If this unit is used in a manner not specified by Moore Industries, the protection provided by the equipment may be impaired.*



## Installation Category

All terminals are rated CAT II.

## Equipment Ratings

Moore Industries transmitters do not generate hazardous voltages. They measure voltage or current inputs, and generate low voltages and currents (<42Vdc and <25mAdc). Products connected to Moore Industries transmitters should be designed to receive these inputs.

## Supply Wiring

All power connections shall be made with 16 to 20 AWG wire. The end of each conductor should be stripped no more than 8mm. The end of the stripped wire should be tinned with solder or inserted into a ferule and crimped before being placed into a terminal block.

## Mounting

When mounting the unit or installing it into an application, ensure that the unit can be easily removed for maintenance or repairs.

## Cleaning and Maintenance

Maintenance on Moore Industries' products is limited to keeping the unit clean and the wire terminals free of oxidation. This is best accomplished by installing the unit in an area protected from dust, heat, moisture, and corrosive atmospheres. Yearly visual inspections should be performed to ensure that the unit is clean and the electrical connections are in good repair.

## Replacement of Consumable Materials

No consumable materials are used in the Moore Industries' products covered by EN 61010-1.

## Customer Support

Recognized as the industry leader for delivering top quality products and services to our customers, Moore Industries is dedicated to quality. If any product fails to perform up to rated specifications, call us for help. Our team of technicians and engineers will provide timely, accurate, and practical answers to your process instrumentation questions.

If problems involve a particular MIX, there are several pieces of information you can gather before you call the factory that will help our staff get your answers more efficiently. When you call, please have:











- The model number of the unit in question
- The serial number of the unit in question
- The job number (if available)
- The purchase order under which the unit was shipped (if available)

Factory contact information is on the back cover.

## Symbols

Table 2 shows the symbols used on Moore Industries' products, the corresponding IEC/ISO symbol, and its definition.

**Table 2.** Symbols on Moore Industries' Products

IEC/ISO Symbol	Symbol on Moore Industries Product	Definition
	+PS -PS DCC	Direct Current
	AC ACC	Alternating Current
	C or DC	Direct and Alternating Current
	GND 	Protected Earth Terminal
		Protective Conductor Terminal
		Equipment protected throughout by double insulation or reinforced insulation (equivalent to Class II of IEC 536)
		Caution (See manual for information)
Not Specified	+INPUT -INPUT	Positive Input Negative Input
Not Specified	+OUTPUT -OUTPUT	Positive Output Negative Output
Not Specified	NO NC CM	Normally Open Normally Closed Common
Not Specified	UNO UNC	Upper Normally Open Upper Normally Closed
Not Specified	LNO LNC	Lower Normally Open Lower Normally Closed
Not Specified	X	Transmitter Excitation

## **Warranty Disclaimer**

Moore Industries ("The Company") makes no express, implied or statutory warranties (including any warranty of merchantability or of fitness for a particular purpose) with respect to any goods or services sold by the company. The company disclaims all warranties arising from any course of dealing or trade usage, and any buyer of goods or services from the company acknowledges that there are no warranties implied by custom or usage in the trade of the buyer and of the company, and that any prior dealings of the buyer with the company do not imply that the company warrants the goods or services in any way.

Any buyer of goods or services from the company agrees with the company that the sole and exclusive remedies for breach of any warranty concerning the goods or services shall be for the company, at its option, to repair or replace the goods or services or refund the purchase price. The company shall in no event be liable for any consequential or incidental damages even if the company fails in any attempt to remedy defects in the goods or services, but in such case the buyer shall be entitled to no more than a refund of all monies paid to the company by the buyer for purchase of the goods or services.

Any cause of action for breach of any warranty by the company shall be barred unless the company receives from the buyer a written notice of the alleged defect or breach within ten days from the earliest date on which the buyer could reasonably have discovered the alleged defect or breach, and no action for the breach of any warranty shall be commenced by the buyer any later than twelve months from the earliest date on which the buyer could reasonably have discovered the alleged defect or breach.

## **Return Policy**

For a period of thirty-six (36) months from the date of shipment, and under normal conditions of use and service, Moore Industries ("The Company") will at its option replace, repair or refund the purchase price for any of its manufactured products found, upon return to the Company (transportation charges prepaid and otherwise in accordance with the return procedures established by The Company, to be defective in material or workmanship. This policy extends to the original Buyer only and not to Buyer's customers or the users of Buyer's products, unless Buyer is an engineering contractor in which case the policy shall extend to Buyer's immediate customer only. This policy shall not apply if the product has been subject to alteration, misuse, accident, neglect or improper application, installation, or operation. THE COMPANY SHALL IN NO EVENT BE LIABLE FOR ANY INCIDENTAL OR CONSEQUENTIAL DAMAGES.

### **To return equipment to Moore Industries for repair, follow these four steps:**

1. Call Moore Industries and request a Returned Material Authorization (RMA) number.

#### **Warranty Repair –**

If you are unsure if your unit is still under warranty, we can use the unit's serial number to verify the warranty status for you over the phone. Be sure to include the RMA number on all documentation.

#### **Non-Warranty Repair –**

If your unit is out of warranty, be prepared to give us a Purchase Order number when you call. In most cases, we will be able to quote you the repair costs at that time. The repair price you are quoted will be a "Not To Exceed" price, which means that the actual repair costs may be less than the quote. Be sure to include the RMA number on all documentation.

2. Provide us with the following documentation:
  - a) A note listing the symptoms that indicate the unit needs repair
  - b) Complete shipping information for return of the equipment after repair
  - c) The name and phone number of the person to contact if questions arise at the factory
3. Use sufficient packing material and carefully pack the equipment in a sturdy shipping container.
4. Ship the equipment to the Moore Industries location nearest you.

The returned equipment will be inspected and tested at the factory. A Moore Industries representative will contact the person designated on your documentation if more information is needed. The repaired equipment, or its replacement, will be returned to you in accordance with the shipping instructions furnished in your documentation.



**Demand Moore Reliability • www.miinet.com**

United States • info@miinet.com  
Tel: (818) 894-7111 • FAX: (818) 891-2816

Australia • sales@mooreind.com.au  
Tel: (02) 8536-7200 • FAX: (02) 9525-7296

BeNeLux • info@mooreind.eu  
Tel: 03/448.10.18 • FAX: 03/440.17.97

China • sales@mooreind.sh.cn  
Tel: 86-21-62491499 • FAX: 86-21-62490635

United Kingdom • sales@mooreind.com  
Tel: 01293 514488 • FAX: 01293 536852